



- Intel® Core i5 8265UE
- up to 32 GB RAM
- Extended power supply range from 9V to 24V
- 2x LAN Intel® Gigabit Ethernet
- 2x 4K Video interface (HDMI - DP)
- Fully customizable push button panel
- High quality anodized aluminum
- Full-IP65 & Fanless cooling
- Integrated SuperCAPS UPS (on request)
- Flexible VESA mounting for any mounting system

IndustrialPAD 156K

Made in ITALY



MAINBOARD

CPU: Intel® Core i5 8265UE
4 Core / 8 Thread
1.6 GHz (Base) / 4.1GHz (Turbo) 15W

MEMORY

Capacity: up to 32GB
Frequency: 2400 MHz
Type: 1x SO-DIMM DDR4L

STORAGE

SATA: 1x SATA3
M.2: 1x M.2 M-Key (2242/2260/2280)
Support PCIe x4 (NVMe) & SATA
Storage Bay: 1x Internal 2.5" SSD Bay (optional)

I/O INTERFACE

Serial ports: 1x COM RS232/422/485
1x COM RS232
USB ports: 4x USB 3.1,
1x USB Type C (3.1 Gen 2)
(Only for DATA)
M.2: 1x M.2 E-Key (2230)
CNVi WIFI module (optional)
AUDIO: 1x Headphone Jack,
1x MIC Jack,
1x Line-out Jack,

VIDEO

GPU: Intel® UHD Graphics
Interface: 1x HDMI 1.4 (Up to 4096x2304 @30Hz)
1x DP 1.2 (Up to 4096x2304 @60Hz)

Display

Size: 15.6"
Resolution: FullHD (1920x1080)
Aspect Ratio: 16:9
Backlight: Led
Bright and Contrast: 300 cd/mq 5000:1

Touch Screen

Glass Thickness: 3 mm
Technology: Projective Capacitive Multitouch - 10 point

ETHERNET

LAN: 1x Intel i219LM PHY Gigabit LAN (iAMT 11.0)
1x Intel i211AT Gigabit LAN

MECHANICAL

Material: Anodized aluminum
Dimensions: (W)466x(D)358.5x(H)60.3mm
Weight: 10 Kg
Mounting: VESA Mounting

SARC ITALIA SRL

Strada Albareto, 503 - 41122 Modena - ITALY
Tel. +39 059 8751076 Fax. +39 059 8751025



Website: www.sarcitalia.it

Email: info@sarcitalia.it

POWER

Power in:	9 to 24V, DC-in
Power consumption:	40W max
Integrated UPS:	On request Feature
	SuperCAPS type battery
	<60 sec charging time
	Backup time 30 ~ 50 sec

ENVIRONMENT

Operating temp.:	-20°C ~ 60°C
Storage temp.:	-20°C ~ 70°C
Humidity:	40% ~ 60% Humidity, non-condensing
EMC:	CE, FCC, RoHS, LVD

Interface Layout Diagram:

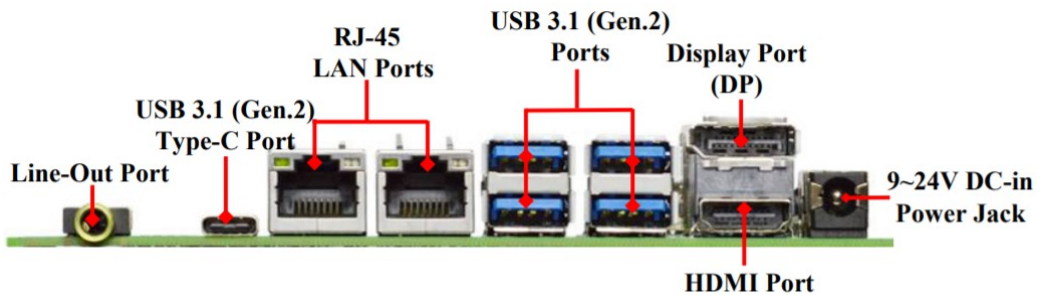

Some Features:

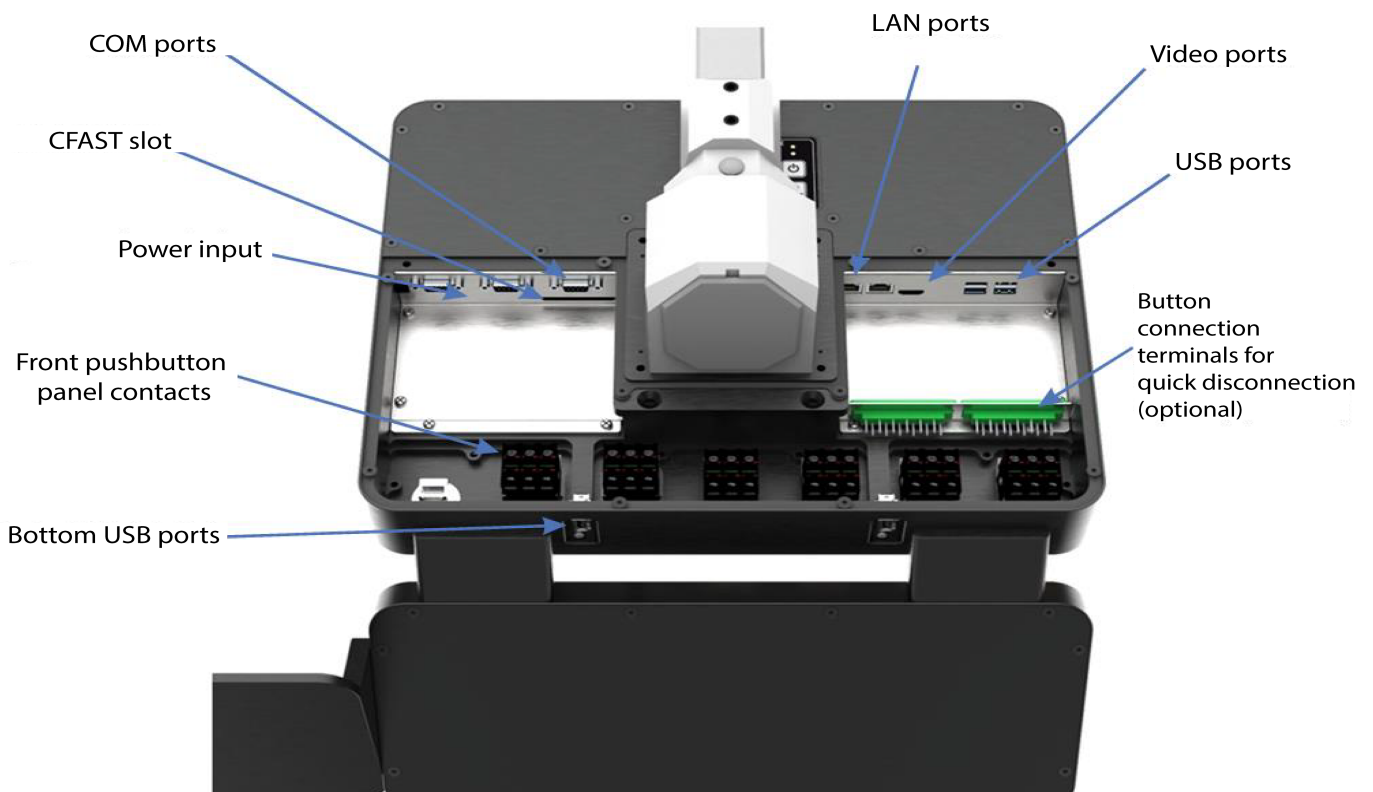

INDATECH®

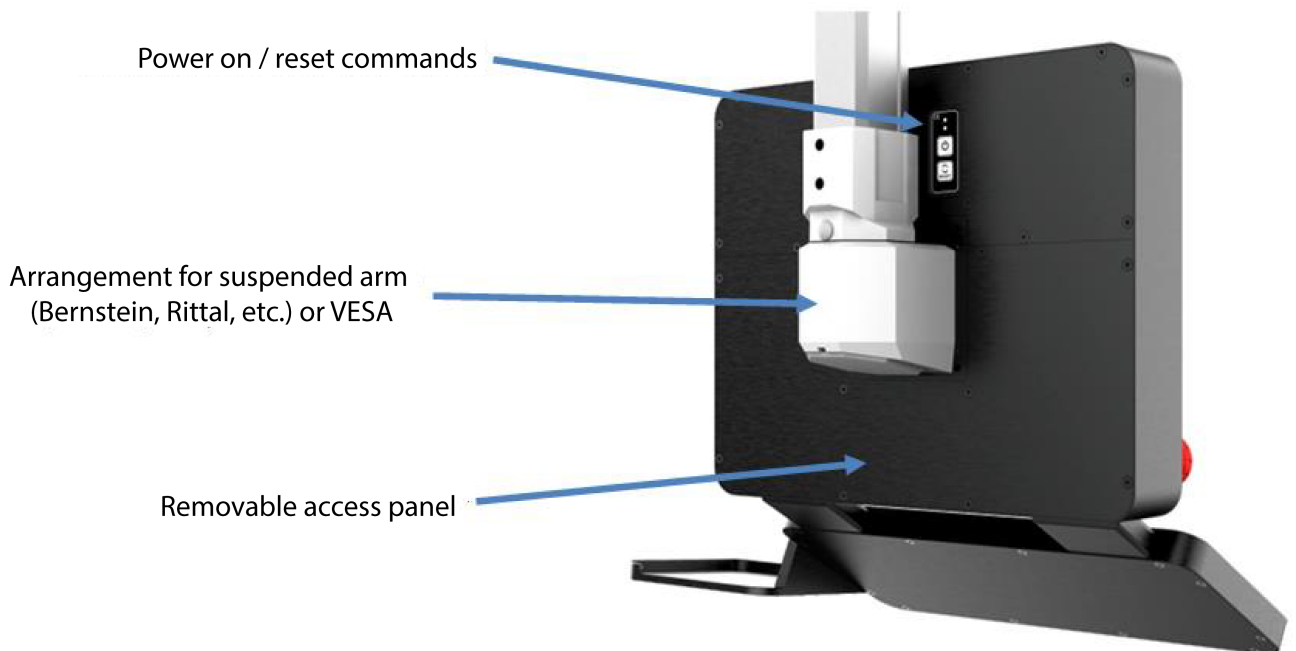
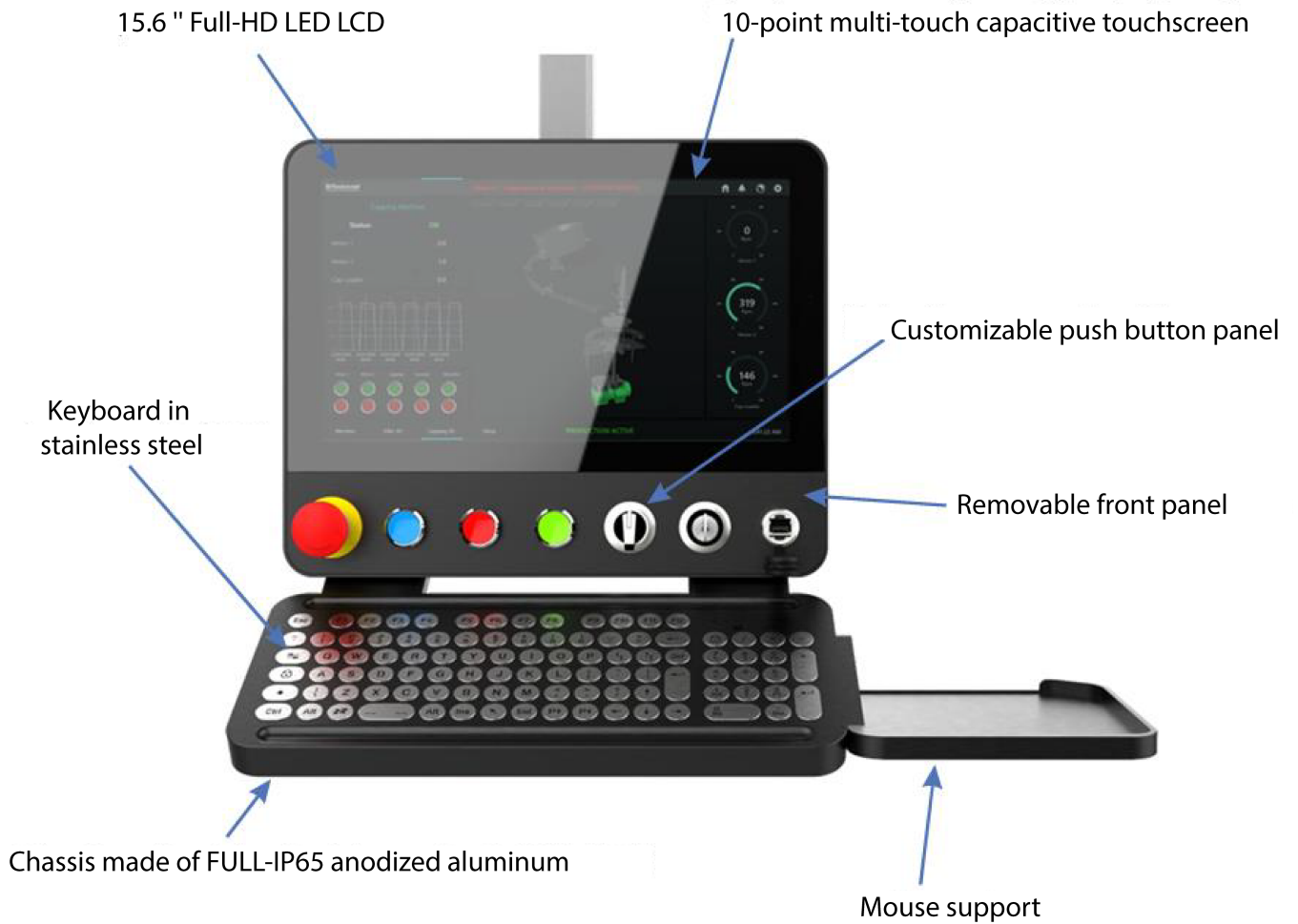

SARC ITALIA SRL

Strada Albareto, 503 - 41122 Modena - ITALY
Tel. +39 059 8751076 Fax. +39 059 8751025



Website: www.sarcitalia.it

Email: info@sarcitalia.it

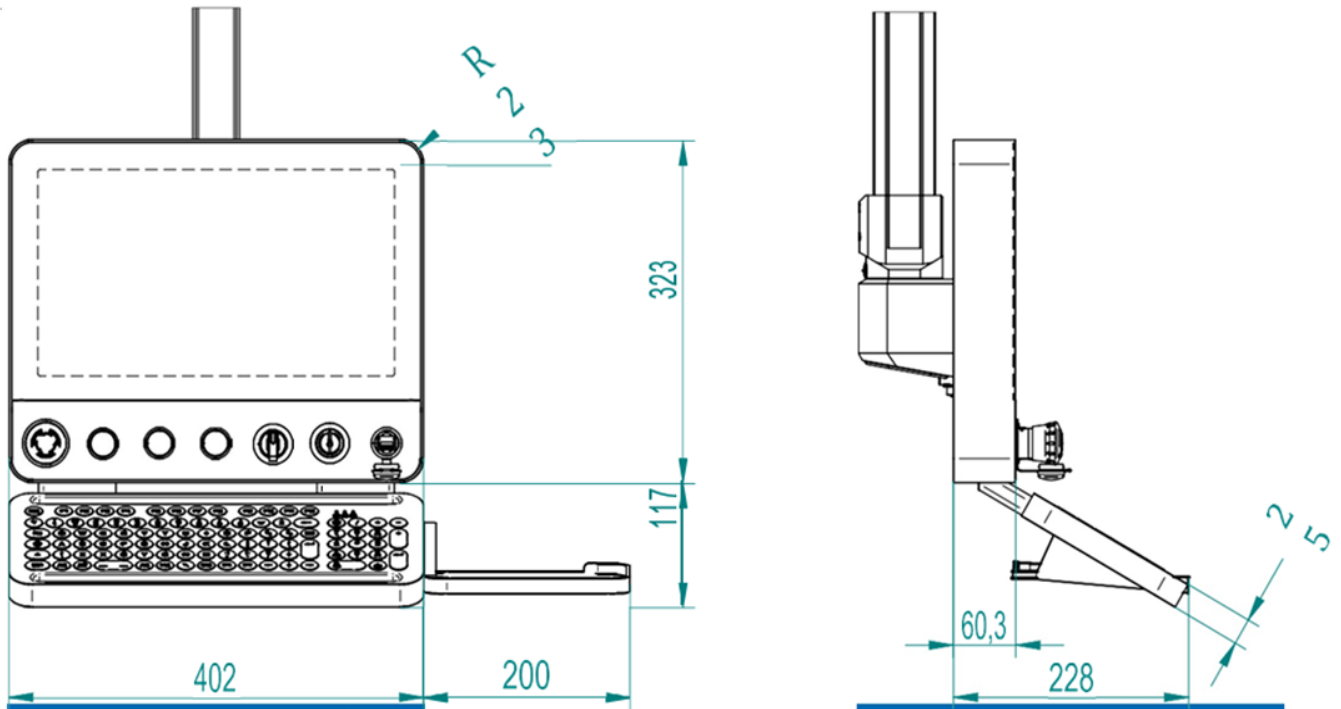

Example push-button panel for references

Accessories Included:



- Phoenix connector 3-pin for Power IN
- Custom VESA Mount Kit

Order Code:

Cod. **10004962**

IndustrialPAD 185 - 18,5" WXGA (1366 x 768), 8GB RAM,SSD250GB,
6 PULSANTI + FUNGO + USB, ALIM. 24 VDC

Compatible OS:

WINDOWS (64bit)		LINUX	
	Windows 10		CentOS 7
	Windows 10 Enterprise LTSC (IoT)		Debian 9.9
			Fedora 30.1.2
			Ubuntu 18.04
			pfSense 2.4.4